

Original Research

The Designing and Optimization of Solar Dryers for Improving the Quality of Dates in Khairpur, Pakistan

Zubeda Bhatti^{1*}, Syed Zafar Ilyas², Muhammad Bachal Korai³, Ali Ibrahim Shar³

¹Department of Physics, Shah Abdul Latif University, Khairpur, Sindh, Pakistan

²Department of Physics, Research Complex, Allama Iqbal Open University Islamabad, Pakistan

³Institute of Chemistry, Shah Abdul Latif University, Khairpur, Sindh, Pakistan

Received: 21 December 2021

Accepted: 5 April 2022

Abstract

The present work was conducted to develop an efficient solar dryer for improving date fruit quality of Khairpur, Pakistan. Three different dryers were developed i.e., a natural convective solar dryer, direct solar dryer and an oven solar dryer comprising air velocity of 0.5 m/s, 0.6 m/s and 0.4 m/s respectively. The temperature inside the three dryers significantly increased with the increase in time interval from 2 to 10 hrs. An average temperature ranged from 40.4 to 41.4°C after 2 hrs which was significantly higher ($p < 0.0001$) than the air temperature outside (36.4°C) the three dryers. Moreover, increased up to 47.9°C after 10 hrs of interval. Average highest temperature recorded in oven dryer was 41.4, 41.9, 45.8, 41.8 and 47.9 after a time interval of 2, 4, 6, 8 and 10hrs respectively. The highest solar radiation was observed as 985 W/m² at 2:30 pm and average solar radiation was found to be 791 W/m². The highest percentage of total sugar (67.7%), non-reducing sugars (18.1%) and reducing sugars (49.54%), proteins (31%) and calcium quantity (32.59 µg/g) was found in conventional dryers, which was followed by (66.88%) of total sugars, (49.6%) of reducing sugars and (17.61%) non-reducing sugars in direct dryer and (2.19%) of proteins and (22.76) µg/g of calcium in oven dryer. The results revealed that the drying natural oven solar dryer provided a good quality dates with satisfactory and competitive to enforce convective solar drying process. The drying time found to be approximately 8 hours daily and total 5 days taken to complete process of drying dates presents the advantage of being able to avoid the discontinuity of the treatment and to discard the night conservation problems. Owing to its low cost and green energy use, this study offers an efficient alternative to convective drying under open sunlight for making quality dates.

Keywords: green energy, temperature, dates, solar dryer

*e-mail: zubeda.bhatti@salu.edu.pk

Introduction

Pakistan is ranked the sixth number in top ten dates producing countries of the world [1]. Date palm is an important fruit crop for human and livestock grown in arid as well as semi-arid areas all over the world [2]. The date palm is an important component of the oasis ecosystem. It plays a vital role in economic growth of countries by marketing date fruit and its by-products. Dates fruit consists fleshy pericarp and seed; it is a rich source of nutrients and provide rapid energy due to high carbohydrate content [3-6]. Due to high content of carbohydrates, dates are taken to break fasting to provide energy immediately. Dates are also rich in dietary fibre content (\approx 8.1-12.7% dry matter basis) [7]. Dates of more than 5,000 date palm cultivars are being cultivated throughout the world [8, 9]. According to FAO [1] are harvested on over 95,902 hectares in Pakistan with an annual production of 49,4601 tonnes. During last thirty years world dates production extensively increased to triple [10]. Of the four provinces of Pakistan, Sindh hold the largest diversity (more than 300 cultivars) of date palm cultivars [11], where Khairpur District and a small area of Sukkur district produce about 85% of the total dates [6]. Early seventy percent of the dates in Sindh are converted into dried for export. In Pakistan and India, the major share of dry dates are consumed in religious ceremonies [12]. Drying of dates fruit is an important post-harvest process to produce the quality dates to meet international standard in market. This process is used to reduce the moisture content of fruit to improve the fruit quality, minimize post-harvest losses and extend shelf life [13]. The cultural and traditional practice is used to dry fresh dates on mats in open areas for making dried dates are known as Tamar. This cultural practice of sun drying dates is cheap and has many disadvantages e.g. dust, birds, animals and microbial contamination. The difficulty of access to energy sources, the high cost of energy and the pollution of the environment have increased the focus on renewables. Solar energy has emerged as a prominent renewable energy research topic [14]. The energy from the sun is a potential candidate for a major source of energy in the future due to its ability to produce zero-emission energy. Photovoltaic technology, that transforms the radiation of the sun to electrical energy, is widely available and affordable technology [15]. The alternative of open sun drying is controlled solar dryer using glass panels have several advantages over the traditional drying including the drying under clean hygienic conditions to national and international standards, to speed up the dates drying process, save the space many folds and ensure the quality of dates mechanical [16, 17]. The process of drying is considered one of the ideal techniques which may be employed to guarantee that the product will remain unspoiled for a long time. Since commercial drying methods need a large amount of energy, the use of alternative sources of energy is usually opted in order to decrease

the consumption of energy in these systems [18]. Few old traditional approaches, such as insulation, are used to save energy in a thermal system; though this might not be viable for mini-scale systems [19]. The drying process is necessary in order to be able to use the woody biomass for different purposes, for example for heating [20]. The use of solar dryers is very cost-effective in operational costs, although the initial investments are high. However, the drying process cannot be carried out in the absence of sunlight [18]. The solar drying is considered to be one of the most common applications of solar energy. However, there is no avoiding the fact that drying uses a large quantity of energy, which in most cases is supplied by fossil energy sources or electricity. When both parameters are considered at the same time, PVT dryers could be promising. The main objective in solar thermal systems is usually to enhance the solar irradiation utilization factor from the sun [21]. Systems the solar drying system is a cheap/cost-effective and good alternative to cultural and during crop harvest season in sunny areas [22]. The vegetables and fruits can be dried like tomato, onion, pepper, garlic and spinach [23-25], banana [26] and dates [27, 28] by using solar drying system to maintain the international standards of both vegetables [29]. Solar dryers are alternative to dry date fruits on mats in open area. This system has many benefits over the traditional system because it is saving energy, time and occupies less area to get good date products efficiently. Dates production increased many folds in last decade due to use of solar dates drying system [30]. Several studies are being conducted for the dates drying and vaporization to develop method for production of quality dates [31]. Khairpur and Sukkur being the major areas of date's production in Sindh, Pakistan, the amount of harvest will assure constant product availability and hence set up dryness and desiccation necessities. So, local farmers and growers of the area will get benefit by utilizing Dry Dispersible powder plant. There will be merely a minimal transportation cost to transport the product to the site because of the vicinity. It is also beneficial for time conservation and could help in fast growing business. The main purpose of current study was to design and optimize solar dryers to develop the quality of Aseel dates variety from Khairpur district, Sindh-Pakistan.

Material and Methods

Material

The Aseel variety was selected for this experiment as pre-dominant and commercial variety of Khairpur. The mature date's fruit of Aseel variety was collected from Date Palm orchards of Khairpur for the experimentation.

Method

Design and Construction of Dryers

Three different solar dryers

1. Convectional Solar Dryer
2. Direct Solar Dryer
3. Oven Solar Dryer were designed for drying of dates.

A convectional solar dryer was designed in cylindrical shape fitted with exhaust fan to outlet air; containing an inclined plate solar collector to the drying chamber where dates were dried. Dates were placed on wire fabricated tray to perform the drying experiment on date samples. Direct solar dryer was designed in triangle shape for drying experiment on date samples and a window was made for outlet air. Convection system and Oven solar dryers were designed in cubical shape to perform the drying experiment; holes were made from sides to outlet air (Fig. 1 and 2). The collector dryer assembly was made of white transparent sheets used as solar radiations absorber surface. Locally available material was used for making all the three dryers. The whole assembly was encased in thick

wooden frames with cover to avoid interaction from environmental variations. According to buoyancy force effect, flow of air in the dryers was brought because of temperature difference inside as well as outside of the dryers. The solar dryer outfit was located on the roof of the Department of Physics, Shah Abdul Latif University, Khairpur, Sindh, Pakistan at a longitude 68°45'-40°90' East and latitude 27°29'-41°35' North, at 96 ft. above the sea level. The drying work was performed on 25th to 29th of August 2019. Experimental work was started at 8:30 a.m. to get the steady-state settings and product was loaded in drying chamber from 9:00 a.m. to 6 p.m. of a sunny day. It was designed as airplane solar collector (2.0×1.0×0.13) m in inclined direction of 16°C about the horizontal as well as vertical directed to south. The drying rooms were fabricated with transparent sheet (1.0×0.8×0.8 m) in direction thermally separated with polystyrene over the outer walls and added a chimney in galvanized sheets (1.0×0.02×0.02 m). The total solar radiations were transferred in the captor field which is measured in W/m² by digitalized display sunshine recorder during experiment on that day. Chemical analyses of all the dried date fruit samples were

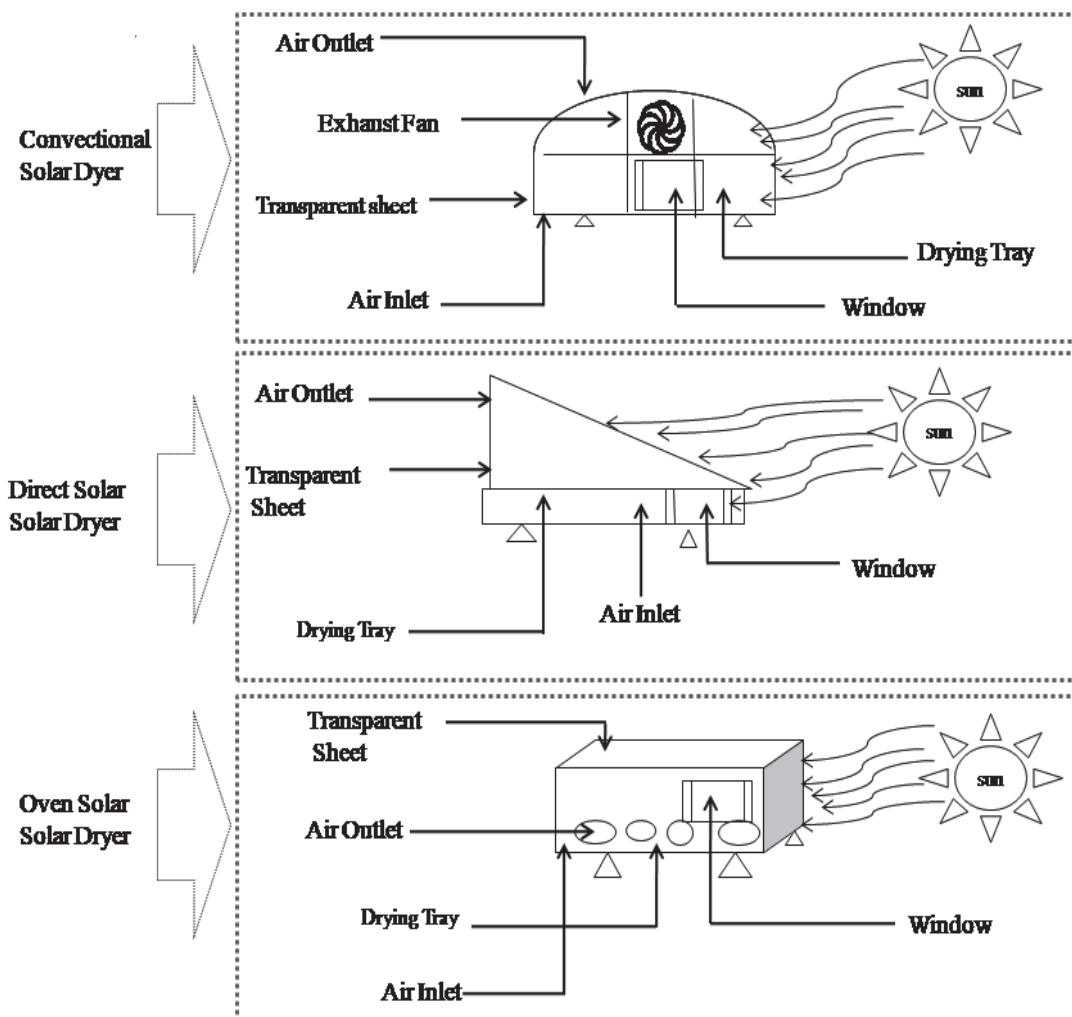

Fig. 1. Design of the convectional, direct and oven dryers.

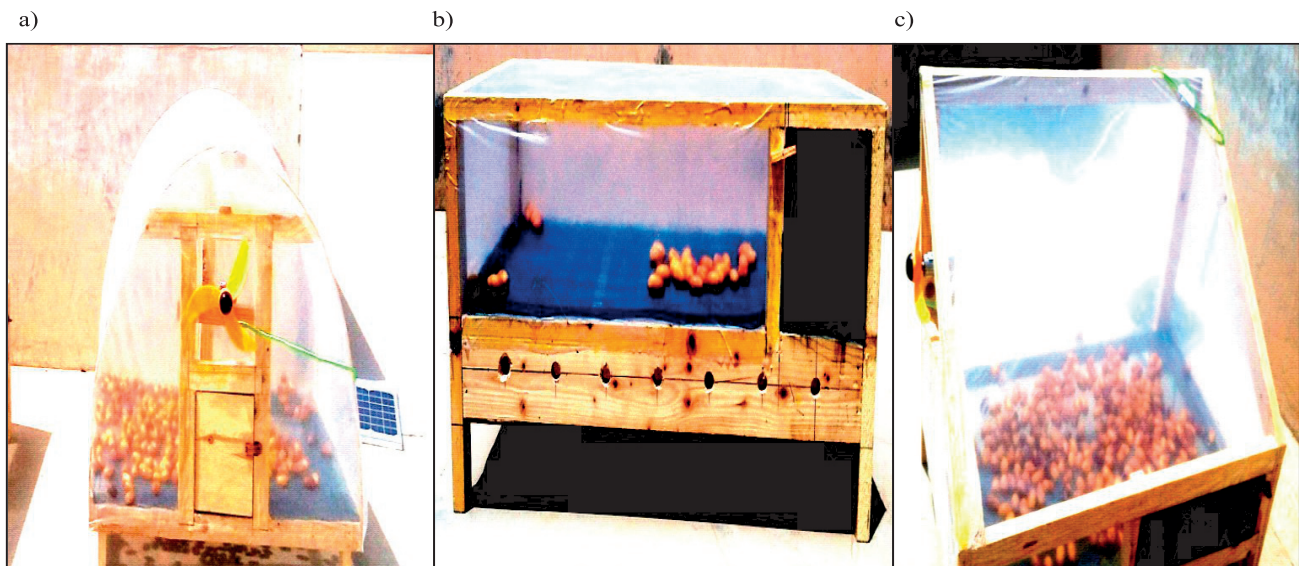

Fig. 2. Drying of the aaseel dates under convectional a), direct b) and oven c) dryer.

conducted to check the quality of dates. The chemical parameters included reducing and non-reducing sugars, total carbohydrates, proteins and calcium. The technical data of all the three dryers is presented in Table 1.

Instrumentation and Experimentation

Throughout experimental study, different equipment was used for analysis of metals and weighing of samples and preparations of solutions. Measurement of temperature and humidity were recorded with thermometer and Hygrometer and wind velocity by Anemometer. The pyranometer was used for analysing the solar radiation flux incident onto the horizontal surface in solar dryer. Temperatures of air and ambient relative humidities at different points within solar dryer have been monitored at different timings. The air temperature over the base of air chamber was

recorded at the pinnacles of 18cm, 36cm, 54 cm and 72 cm respectively. Temperatures of air stream of solar dryers were recorded too at 40 cm, 80 cm, 120 cm and 160 cm from open window to the exhaust fan in longitudinal way. Time was noted at three hours interval of three hours for integrated measurements. Total Carbohydrates (490 nm), reducing sugar (540 nm), Proteins (510 nm), calcium (247 nm) and Fats (450 nm) were recorded on different wavelengths by using double beam spectrophotometer (Model CECIL9500). The weight of date fruits was recorded at different time intervals.

About 10 kg fruit of Aaseel date palm variety was collected from Date Palm Orchards of district Khairpur. The collected dates were brought to the department of Physics, Shah Abdul Latif University, Khairpur and necessary parameters were recorded like total fruit weight, etc. The dates were transferred to the trays

Table 1. Specifications of the convectional, direct and oven dryers.

Specification	Convectional	Direct	Oven
Length	2.6 Feet	3 Feet	3 Feet
Width	3 Feet	2 Feet	1.10 Feet
Collector area	1 square foot	1 square foot	1 square foot
Drying Area	2.6 m ²	2.9 m ²	2.10 m ²
Air Temperature	40°C	40°C	40°C
Power requirement	15 Watt	15 Watts	Nil
Drive of fans	Solar Panels	Solar Panels	Nil
Price	80000	8000	80000
Number of Fans	01	01	Nil
Control	Self-regulated air flow and temperature (Solar Panels Types)	Self-regulated air flow and temperature	Self-regulated air flow and temperature

which were later placed into the drying units for drying. The temperature and humidity meters were set for recording the data in all solar dryer. The fully dried dates were taken out and cooled at normal temperature prior to departure the site. The parameters noted during the drying process were Drying Time (Dt), Air Temperature (T^{air}), Product Temperature (T^p), Product Weight (Water content of dates) (M), Moisture content (Initial & Final) (X^i), Relative Humidity (H^r), Air velocity (V) and Solar Radiation intensity (I).

Chemical Analysis of the Dried Date's Samples

The dried dates samples were collected from all the three dryers for total sugars, reducing sugars, non-reducing sugars, protein content and calcium analysis. The total sugars were determined through the Phenol-Sulfuric Acid according to method of Albalasmeh, Berhe [32]; reducing sugars were determined using Denitrosalicylic acid (DNSA) method [33]. Non-reducing sugars were calculated by the difference between reducing sugars and total sugars. The protein contents were determined through the Bradford method [34] and calcium contents were determined as per Al-Seeni [35].

Uncertainty Analysis

Uncertainty detection allows displaying the accuracy of the estimated parameters. The uncertainty values calculated can be seen in Table 2. The calculated uncertainty values are shown in Table 2. The values of uncertainty obtained are in good agreement when compared with the related research reported in the literature in which various kinds of solar drying systems have been studied [21].

Results and Discussion

Air Temperature, Relative Humidity and Air Velocity

The drying of fruit or vegetables is a classical method of food preservation by removing the moisture using heat [36]. In this process of drying, heat and air velocity plays an important role for evaporation of the moisture and its subsequent removal from the vicinity of a product. According to Selvaraj and Sadagopan [36],

Table 2. Uncertainty values observed experimentally

Parameters	Units	Uncertainties
Temperature	°C	±0.50
Solar radiations	Wm ⁻²	±15.25
Air velocity	m ⁻¹	±0.34
Drying efficiency	%	±1.00

the drying of a food product is a process of heat and mass transfer which rely on external (temperatures, air velocity and humidity) and inner variables (characteristics of the surface, physical and chemical composition, shape and size) of the product. However, the duration of time and increase in temperature may be limited to its optimum ranges which depends upon the fruit type and cultivar. The colour of Deglet Nour was reported dark a when an increase in time and temperature was done during the drying process [6]. This paper describes the design, construction and experimental investigation of three different solar dryers which were identified passive and natural circulation of solar energy in dryers. These dryers can be easily fabricated and operated suitably at small scale during overall processing [37]. Fig. 3 showed that as compared to outside temperature, the inside temperature was observed higher in all the three dryers at five different time intervals (2, 4, 6, 8 and 10 hrs). During the 2 hrs time interval, the air temperature inside the convectional, direct and oven dryers was 40.4, 40.4 and 41.4°C which was significantly higher ($p < 0.0001$) than the air temperature outside (36.4°C) the three dryers. The temperature increased with increase in time interval from 2 to 10 hrs. The maximum temperature recorded after 10 hrs of interval 47.9°C in oven dryer followed by 43.6°C in Direct dryer and 42.5°C in convectional dryers as the minimum temperature noted inside the three dryers. The maximum air temperature outside the dryer after 10 hrs interval was 39.6°C. With the increase of solar radiation from 265 W/m² during morning time to 1095 W/m² at noon, the air temperature in the collector changes depending on the daily radiation falling on the collector. The highest solar radiations were observed as 985 W/m² at 2:30 pm and average solar radiations were found to be 791 W/m². In contrast, the relative humidity (%) was found significantly lower in air inside the three dryers than the air outside the dryers Fig. 4. It can be seen in the Fig. 4 that the minimum relative humidity noted after 2 hrs interval was 46% in Direct dryer, which was lowered than the relative humidity noted in convectional

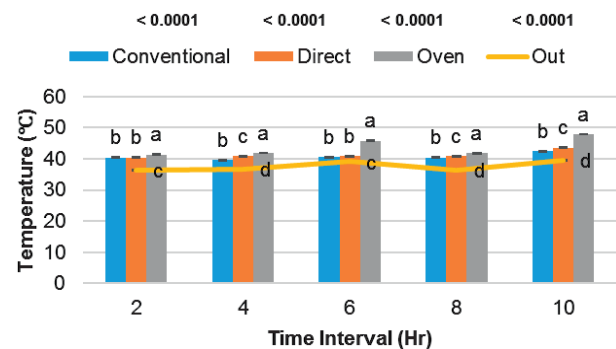

Fig. 3. Temperatures inside the three dryers (convectional, direct and oven) and outside all the dryers during at different time intervals (hours).

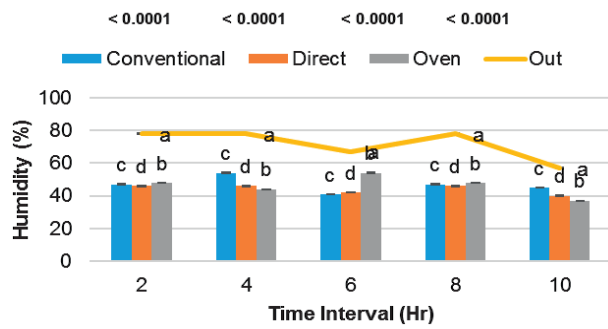

Fig. 4. Humidity (%) inside the three dryers (convectional, direct and oven) and outside all the dryers at different time intervals (hours).

dryer (47%) and in Oven dryer (48%) as well as outside air (78%) in all the three dryers. The relative humidity decreased with increase in time interval from 2 hrs to 10 hrs. The relative humidity inside the three dryers after 10 hrs of time interval was 45% in convectional dryer, followed 40% in direct oven and 37% in Oven dryer, which were significantly higher than the relative humidity noted in the air outside (57%) the dryers.

No constant rate of drying period was observed. The moisture reduced continuously with cumulative drying hours while the average air flow velocity inside the dryers were 0.4 m/s, 0.5 m/s and 0.6 m/s (Fig. 5). The performance of dryers and open air sun drying was observed which showed decrease in drying time as compared to natural open air sun-drying. The present work revealed that solar dryers can be employed for drying of date fruits at lower temperature because of closed chamber to control temperature where the electricity is not available and less hygienic due to contamination by dust and insect. Therefore, the thermal performance analysis of drying time of 24-30 hours is assumed for the anticipated test. The results of present study showed that the dates dried on 0.0348 m³/s volume flow rate and the best quantity compared to drying at 0.5 and 0.6 m/s flow rate for the same solar energy input and atmospheric condition.

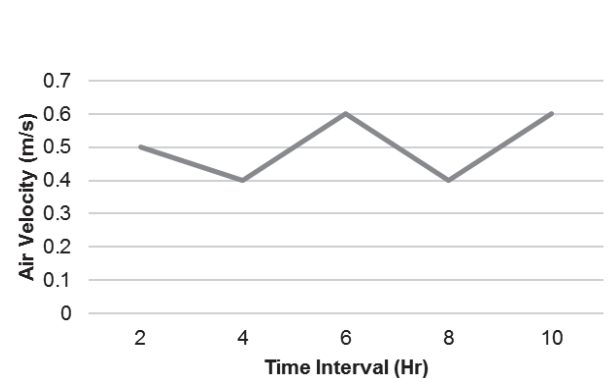

Fig. 5. Air velocity recorded outside all the dryers at different time intervals (hours).

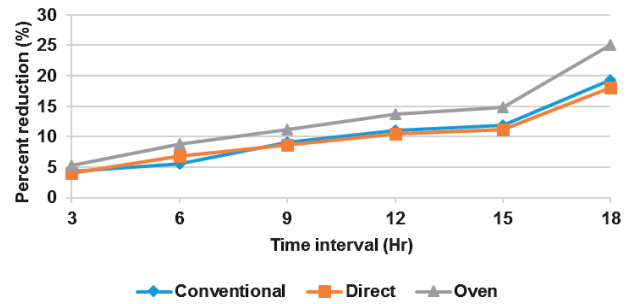

Fig. 6. Percent reduction in weight of date fruits at different time intervals in convectional, direct and oven dryer.

Drying Efficiency of the Dryers

The utilization of solar energy in drying process of dates or other fruits and vegetables is a better choice for reducing the use of fossils fuel [4] and decreasing the carbon input into the atmosphere. The efficiency of a solar dryer is determined through the rate and amount of moisture it can be removed from the fruit samples. Fig. 6 shows a significant variation in percent reduction of date's fruit weight among all the three dryers at 3, 6, 9, 12, 15 and 18 hrs time intervals. The highest decrease in fruit weight at 3 hrs interval was 5.2% noted in Oven dryer, followed by 4.25% in Convectional and 3.98% in Direct dryer. Fig. 6 shows the reduction percent in weight of the fruit increased with increase in time interval from 3 hrs to 18 hrs. The highest decrease was noted at 18th hr as 25.05% in Oven, followed by 19.36% in convectional dryer and 18.10% in oven dryer as the least reduction in fruit weight among the three dryers after 18 hrs of interval. The results obtained in current study are in agreement with the results published by Babagana, Silas [29] who used solar dryers for drying tomato, onion, pepper, okra and spinach. Similar observations have been reported by Mennouche, Boubekri [6] and Lingayat, Chandramohan [4] that the drying process increases faster with an increase in temperature inside the dryers and the time interval.

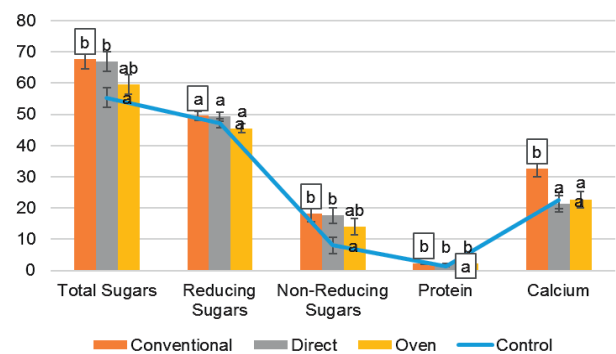

Fig. 7. Chemical profile of aseel dates dried in convectional, direct and oven as compared to the open sun light drying (control).

They also found the significant reduction in an average moisture content from an initial value of 36.5% (db) to the final moisture content value of up to 16.3% (db) [4].

Chemical Analysis of the Solar Dried Dates

The increase in temperature during drying process may affect an overall activity of the enzymes in the fruit for example, with a loss of water the inversion of sugars has been also reported [6, 38]. The data present in Fig. 7 shows the chemical properties of dates dried in conventional, direct and oven dryer. The highest percent of total sugar (67.7%), non-reducing sugars (18.1%) and reducing sugars (49.54%), proteins (31%) and calcium quantity (32.59 $\mu\text{g/g}$) was found in conventional dryers, which was followed by (66.88%) of total sugars, (49.6%) of reducing sugars and (17.61%) non-reducing sugars in direct dryer and (2.19%) of proteins and (22.76) $\mu\text{g/g}$ of calcium in oven dryer. The lowest percentage of total sugars (55.3%), reducing sugars (47.24%), non-reducing sugars (8.06%) and proteins (1.38%) was found in control. The lowest quantity of calcium (21.26 $\mu\text{g/g}$) was found in direct type of dryer compared with open air drying of dates. The difference was found that the time consuming and quality of dates were good against open air-drying dates. The data taken in current study are in agreement with the results published by Mennouche, Boubekri [6] that the chemical composition of the dates dried in dryers is not significantly different from the dates dried using traditional drying process in air-drying. They indicated that the solar dryer can be used for low temperature drying of dates because of closed chamber to control temperature where the electricity is not available.

Conclusions

The radiation from the sun could be very efficient and used to dry agriculture products within our environment if appropriate designing is done. Hence, it was shown, designed, and built solar dryer showed sufficient capability for drying agro products, particularly food products, to significantly reduced humidity level. The current study shows the use of solar dryer with high efficiency up to 8 hours daily and for maximum 5 days were taken to get the good quality of dried dates. Among the three dryers designed and tested, oven dryer proved to be better with maximum temperature reached upto 47.9°C after 10 hours of interval with an average air velocity of 0.4 m/s. The highest solar radiation was observed as 985 W/m^2 and average solar radiation was found to be 791 W/m^2 . The highest percentage of total sugar (67.7%), non-reducing sugars (18.1%) and reducing sugars (49.54%), proteins (31%) and calcium quantity (32.59 $\mu\text{g/g}$) was found in conventional dryers, which was followed by (66.88%) of total sugars, (49.6%) of reducing sugars and (17.61%) non-reducing sugars in direct dryer and (2.19%)

of proteins and (22.76) $\mu\text{g/g}$ of calcium in oven dryer. The lowest percent of total sugars (55.3%), reducing sugars (47.24%), non-reducing sugars (8.06%) and proteins (1.38%) was found in control. The lowest quantity of calcium (21.26 $\mu\text{g/g}$) was found in direct type of dryer compared with open air drying of dates.

Conflict of Interest

The authors declare no conflict of interest.

References

1. KOUSAR R., SADAF T., MAKHDUM M.S.A., IQBAL M.A., ULLAH R. Competiveness of Pakistan's selected fruits in the world market. *Sarhad J. Agric.* **35**, 1175, **2019**.
2. ANAND B.A., BABU P.M., RAJ B.S. Intelligent System Based Solar Biomass Hybrid Dryer for Perishable Crops and Leafy Vegetables. *Int. J. Curr. Microbiol. App. Sci.* **7**, 1701, **2018**.
3. CÉSAR L.V.E., LILIA C.M.A., OCTAVIO G.V., ISAAC P.F., ROGELIO, B.O. Thermal performance of a passive, mixed-type solar dryer for tomato slices (*Solanum lycopersicum*). *Renew. Energy* **147**, 845, **2020**.
4. LINGAYAT A., CHANDRAMOHAN V.P., RAJU V.R.K. Design, development and performance of indirect type solar dryer for banana drying. *Energy Procedia* **109**, 409, **2017**.
5. SEERANGURAYAR T., AL-ISMAILI A.M., JEEWANTHA L.J., AL-NABHANI A. Experimental investigation of shrinkage and microstructural properties of date fruits at three solar drying methods. *Sol. Energy* **180**, 445, **2019**.
6. MENNOUCHE D., BOUBEKRI A., CHOUICHA S., BOUCHEKIMA B., BOUGUETTAIA H. Solar drying process to obtain high standard "deglet-nour" date fruit. *J. Food Process Eng.* **40**, e12546, **2017**.
7. BOUGHALI S., BENMOUSSA H., BOUCHEKIMA B., MENNOUCHE D., BOUGUETTAIA H., BECHKI D. Crop drying by indirect active hybrid solar-Electrical dryer in the eastern Algerian Septentrional Sahara. *Sol. Energy* **83**, 2223, **2009**.
8. KADRI N., BEN MIMOUN M., BEN SALAH M. Study of the effect of three thinning methods on the qualities physical and chemical properties of dates of the "Deglet" variety Nour in the oases of Nefzaoua. *Revue des régions arides* **21**, 1063, **2008** [In French].
9. AL-NAJM A., LUO S., AHMAD N.M., POURKHEIRANDISH M., TRETOWAN R. Molecular variability and population structure of a core collection of date palm (*Phoenix dactylifera* L.) cultivars from Australia and the Middle East. *AJCS.* **11**, 1106, **2017**.
10. BESBES S., BLECKER C., DEROANNE C., DRIRA N.E., ATTIA H. Date seeds: chemical composition and characteristic profiles of the lipid fraction. *Food Chem.* **84**, 577, **2004**.
11. MARKHAND G.S., ABUL-SOAD A., JATOI M. Chemical control of sudden decline disease of date palm (*Phoenix dactylifera* L.) in Sindh, Pakistan. *Pak. J. Bot.* **45**, 7, **2013**.
12. MAHMOUDI H., HOSSEININIA G., AZADI H., FATEMI M. Enhancing date palm processing, marketing

- and pest control through organic culture. *J. Org. Syst.* **3**, 29, **2008**.
13. HUSSAIN I., AHMAD S., AMJAD M., AHMED R. Effect of modified sun drying techniques on fruit quality characters of dates harvested at rutab stage. *J. Agric. Res.* **52**, 415, **2014**.
 14. OZBAS E., SELIMLI S., OZKAYMAK M., SS FREJ A. Evaluation of internal structure modifications effect of two-phase closed thermosyphon on performance: An experimental study. *Sol. Energy* **224**, 1326, **2021**.
 15. SELIMLI S., DUMRUL H., YILMAZ S., AKMAN O. Experimental and numerical analysis of energy and exergy performance of photovoltaic thermal water collectors. *Sol. Energy* **228**, 1, **2021**.
 16. MIRANI A.A., TEO C.H., ABUL-SOAD A.A., MARKHAND G.S., JATT T., MIRBAHAR A.A., SOLANGI N. Phenotypic reversion of somaclonal variants derived from inflorescence of date palm (*Phoenix dactylifera* L.) in the open field trials. *Sarhad J. Agric.* **35**, 719, **2019**.
 17. ELLEUCH M., BESBES S., ROISEUX O., BLECKER C., DEROANNE C., DRIRA N.E., ATTIA H. Date flesh: Chemical composition and characteristics of the dietary fibre. *Food Chem.* **111**, 676, **2008**.
 18. ATALAY H., CANKURTARAN E. Energy, exergy, exergoeconomic and exergo-environmental analyses of a large scale solar dryer with PCM energy storage medium. *Energy* **216**, 119221, **2021**.
 19. YILMAZ AYDIN D., GÜRÜ M., SÖZEN A., ÇİFTÇİ E. Investigation of the effects of base fluid type of the nanofluid on heat pipe performance. *P. I. Mech. Eng. A-J. P.O.W. Ener.* **235**, 124, **2021**.
 20. KHOUYA A. Modelling and analysis of a hybrid solar dryer for woody biomass. *Energy* **216**, 119287, **2021**.
 21. ÇİFTÇİ E., KHANLARI A., SÖZEN A., AYTAÇ İ., TUNCER A.D. Energy and exergy analysis of a photovoltaic thermal (PVT) system used in solar dryer: A numerical and experimental investigation. *Renew. Energy* **180**, 410, **2021**.
 22. AL-SHAHIB W., MARSHALL R.J. Dietary fibre content of dates from 13 varieties of date palm *Phoenix dactylifera* L. *Int. J. Food Sci. Technol.* **37**, 719, **2002**.
 23. AL-HOOTI S.N., SIDHU J.S., AL-SAQER J.M., AL-OTHMAN A. Chemical composition and quality of date syrup as affected by pectinase/cellulase enzyme treatment. *Food Chem.* **79**, 215, **2002**.
 24. JATOI M.A., ABUL-SOAD A.A., MARKHAND G.S., SOLANGI N. Establishment of an efficient protocol for micropropagation of some Pakistani cultivars of date palm (*Phoenix dactylifera* L.) using novel inflorescence explants. *Pak. J. Bot.* **47**, 1921, **2015**.
 25. HAZBAVI I., KHOSHTAGHAZA M.H., MOSTAAN A., BANAKAR A. Effect of postharvest hot-water and heat treatment on quality of date palm (cv. Stamaran). *J. Saudi Soc. Agric. Sci.* **14**, 153, **2015**.
 26. VIJAYAVENKATARAMAN S., INIYAN S., GOIC R. A review of solar drying technologies. *Renew. Sust. Energ. Rev.* **16**, 2652, **2012**.
 27. SELVARAJ M., SADAGOPAN P., VAIRAVEL M. Review on Latent Heat Solar Air Collectors. *Int. J. Adv. Res. Eng. Technol.* **10**, 112, **2019**.
 28. FADHEL A., KOOLI S., FARHAT A., BELLGHITH A. Study of the solar drying of grapes by three different processes. *Desalination* **185**, 535, **2005**.
 29. BABAGANA G., SILAS K., MUSTAFA B.G. Design and construction of forced/natural convection solar vegetable dryer with heat storage. *ARN J. Eng. Appl. Sci.* **7**, 1213, **2012**.
 30. CHANDRASEKARAN M., BAHKALI A.H. Valorization of date palm (*Phoenix dactylifera*) fruit processing by-products and wastes using bioprocess technology-Review. *Saudi J. Biol. Sci.* **20**, 105, **2013**.
 31. SAVIGLIANO R. Implementation of a Demonstration Project on Alternatives to Methyl Bromide for the Treatment of High Moisture Dates (Algeria and Tunisia): the UNIDO's Experience. In IV International Date Palm Conference **882**, 577, **2010**.
 32. ALBALASMEH A.A., BERHE A.A., GHEZZEHEI T.A. A new method for rapid determination of carbohydrate and total carbon concentrations using UV spectrophotometry. *Carbohydr. Polym.* **97**, 253, **2013**.
 33. JAMRO M.M.U.R., LAGHARI G.M., BURIRO M., SOOMRO N.A. 01. Study on yield parameters of major Date Palm (*Phoenix dactylifera* L.) cultivars planted in Sindh, Pakistan. *Pure Appl. Biol.* **5**, 1, **2021**.
 34. BRADFORD M.M. A rapid and sensitive method for the quantitation of microgram quantities of protein utilizing the principle of protein-dye binding. *Anal. Biochem.* **72**, 248, **1976**.
 35. AL-SEENI M.N. Minerals content and antimicrobial efficacy of date extracts against some pathogenic bacteria. *Life Sci.* **19**, 504, **2012**.
 36. SELVARAJ M., SADAGOPAN P. A Review of Solar Energy Drying Technology with Air Based Solar Collectors. *Adv. Nat. Appl. Sci.* **11**, 472, **2017**.
 37. DADI J.F., JUJARA I.H., MALEK J.I., PATEL P.S., BHADORIYA P.S., PATEL V.M. A Review Paper on Solar Dryer. *Int. J. Mod. Eng. Res.* **3**, 2349, **2016**.
 38. HAMDİ S., HAMDİ M. Artificial maturation and drying of Deglet Nour dates. *Fruits* **46**, 587, **1991**.